

Broadway News

Pastor Mick Foster
 Traditional Worship 8:15 am
 Praise & Worship 10:45 am
 Sunday School 9:45 am

Broadway is hosting a Shoebox Packing Party for Operation Christmas Child (OCC)

Time to pack shoe boxes! **Thursday November 1st, @ 5:30.** Come for a light meal and then pack shoeboxes about 6:30pm in Spencer Hall. This will be a fun night of fellowship and packing. Gift-filled shoeboxes are a tangible way to introduce children to God's greatest gift, salvation through Jesus Christ. For many of these children, the gift-filled shoebox is the first gift they have ever received.



You can also pack at home, all shoeboxes need to be in by **Sunday, Nov. 4th.** They will then be taken to the collection site. From the collection site they will be taken to the processing center. At the processing center each shoebox is opened and inspected to make sure all items are appropriate to send. From there they will be taken to the shipping docks for departure to over 100 countries. Last year our shoe boxes went to Malawi and Zimbabwe, Africa, Columbia and Peru!

A donation of \$9 is critical to cover shipping and other project costs. Give and you discover the destination of your shoebox. We will use the labels at the shoe box packing party on November 2. Adopt 1 or more shoeboxes for \$9 each, write on your envelope on the line marked **Other** (adopt a shoe box or OCC shipping.) You may adopt your shoe boxes now until the packing party on November 2. Your **Thanksgiving Offering will go toward OCC postage.** Thank you for your continued support to the Operation Christmas Child shoe box mission.

What goes into the box is fun and what comes out of the box is eternal.
"Anyone who welcomes a little child like this on my behalf welcomes me, and anyone who welcomes me welcomes not only me but also my Father who sent me." (Mark 9:37 NLT).

“SATISFIED AFTER THE HOLIDAYS”



Some years ago in mid-November I was listening at home to Bethany playing the piano. She had progressed from simple to more complex music and was trying to play Christmas songs, working hardest on, “What Child Is This?” She is the youngest of our children and usually the first to bring up Christmas, as she did that year. As early in the season as it was, the stores were even earlier.

Most people have figured out why the stores prepare us so soon for Christmas; it’s their most profitable time of the year. They need the sales. They’re trying to milk it for all they can get. That’s OK, it’s just good business. Of course, good business will emphasize Santa Clause and gift giving more than Jesus Christ and God coming in the flesh to save us.

The trouble is, we who have been saved by Jesus Christ know we should keep Him as the reason for the season, but we get caught up in the world’s focus anyway. We start shopping before Thanksgiving, and some I know, whom I dearly love, start much sooner. One year Seth asked if we could put up the outside lights in early November while it was still warm. Not such a bad idea, but I just couldn’t do it. In my mind that would undermine the importance of Thanksgiving, which the world cares little about anyway because there is not much money to be made from it.

The world wants us to get the Christmas season going as soon as possible. The more we prepare, the more we spend. Well, there is the outside decorating and the inside decorating. It’s nice and all, but look at the money and time we sink into it. And those gifts, they have to be just right. That takes time and money. Becky and I have, in the past, taken out the twelve month savings plan at the bank to be able to afford it. Don’t forget all it takes to send out those Christmas cards. I’m trying to deemphasize them. Then, there are the parties to go to, buy food for, and more, sometimes much more.

Add all the church and religious activities to that list and you have quite a buildup to December 25th. There’s no way the arrival of that day can live up to the preparations and expectations that lead up to it. No wonder so many kids fly through their presents and are irritable the rest of Christmas day. For many it’s quite a let-down. Christmas can’t live up to the world’s expectations.

Now, I know we should enjoy all those preparations as a part of Christmas and not expect that one day to satisfy. But the fact is, many people are depressed after the holidays and take weeks to come out of it.

How might we improve that situation? The answer is simple. Scale down the money and time involved in preparation, and focus more on Jesus Christ. Remember, He was born in a stable. When we put our expectations in Him, we will always be satisfied! Jesus will never disappoint us! He can live up to His billing!

***“Delight thyself also in the LORD; and He shall give thee the desires of thine heart”
(Psalm 37:4).***

Your Witness—Thanksgiving and Christmas—By Don Gibson

As we progress through the Thanksgiving and Christmas season, we will hear any number of people express that they are **thankful or that they “love” Christmas**. These are **door openers** God may lead us to respond to.

If we are in the Word daily and praying that God use us to draw people to Christ (whether believers or not), God will open doors. God will **engineer circumstances giving us opportunities to witness**. We'll pick up on people's words.

Though it's a year-round calling by God, if there's an annual witnessing season, this is it! People refer to being thankful or to Christmas. They talk about visiting, shopping, eating—you name it. Some talk about Christ our Savior's birth. **But here's the point—they bring it up**. It's up to us to **be Spiritually ready to sense God leading us** to ask them a question. Maybe like this.

“Christmas is special to me, too. “What makes Christmas special to you?” Their answers are our entry point. If it's about Christ, we're in a chat with a fellow believer, whether we know them or not. If it's not, the Holy Spirit gives us questions to ask. **The point—get them talking** so we know where to start.

Here's a recent typical opportunity, though not season-related. A repairman for my neighbor asked if he could return for a follow-up visit on Wednesday. Ah, my witnessing entry point. I indicated we would need to wrap-up by 5 because I have church Bible Study soon after. I asked him **if he ever attended a Bible study or worship**. He no. God led me to ask further. “So do you have any kind of a relationship with God? Are you a believer in Christ?” He answered, “Well, I was saved three years ago. I attended church for a while (at a certain church), but I got away from it. I usually have to work on Sundays.” I asked if he read the Bible. No. By then he became tearful saying he should get closer to God. This man was under conviction. The Holy Spirit led him into this dialogue. As a believer, he was starved spiritually. He agreed.

I handed him **Romans 12:2** and I asked him to read it out loud. **He read “...Be ye transformed by the renewing of your mind...”** He looked up and agree he needed that. I gave him the Gideon Bible app for his smart phone and he loaded it right then in my neighbor's garage. He said he would read it everyday. I asked him about church or Bible studies Sunday evenings or week-nights. I'll follow up with him. This man unknowingly opened the door. God led him. God led me. God leads us year-round!

“The harvest truly is great, but the labourers are few: pray ye therefore the Lord of the harvest, that he would send forth labourers into his harvest.” Luke 10:2

This column repeats. Got a witnessing question or testimony to share? Call me at 330-260-7837 or email dgibson@linkpointplanning.com, or contact Tammy in the office.

Thank you! – Don

ALL SAINTS' SUNDAY
November 4th

All Saints' Sunday is a day of remembrance for the saints. This is a time to recognize, honor and memorialize those in our Church family who have died during the past year.

Please contact the church office to submit names for this special service.

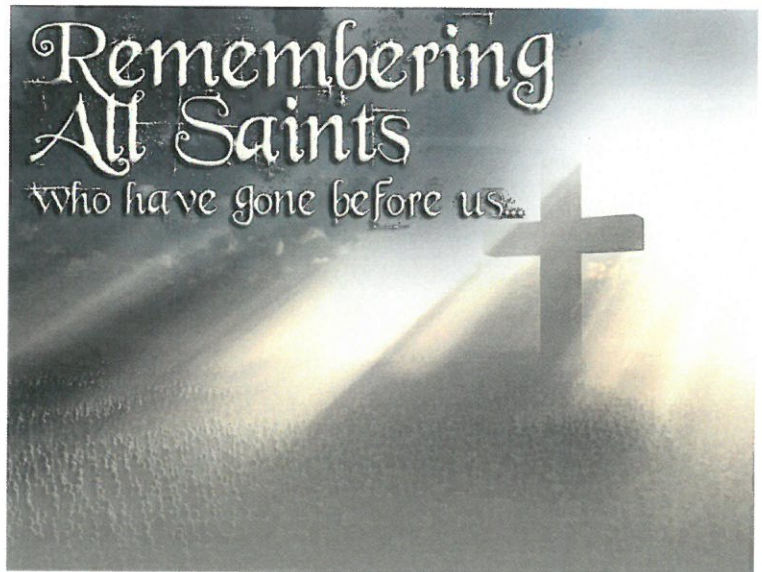

The following guidelines are to determine those to be recognized on this important day on the Christian calendar.

1. Current members of Broadway Church who have attended regularly.
2. Current members of Broadway Church who could not attend regularly due to illness or distance. Consideration shall be given to the length of absence and whether family members will attend the All Saints' Sunday observance.
3. Former members whose spiritual influence is still felt within the Broadway Church family. Consideration shall be given as to whether family members will attend the All Saints' Sunday observance.
4. Those persons who are not members of Broadway but were presently active in the life of our local church at the time of their deaths. Consideration shall be given if illness has kept them from attending.
5. Former pastors of Broadway Church.

Discretion in working within these guidelines shall lie with the Pastor.



Mission of the Month for November: Ann Spencer Food Fund

This is a new Mission Project providing Thanksgiving Dinners and Christmas Dinners to individuals in need, providing milk to Harbor House (6 to 8 gallons a week) and an available resource for church members who have been hospitalized, had surgery, etc. and are in need of some meals. Other food needs will be addressed as they are brought to our attention to utilize this new project. A great way to show our love to our brothers and sisters in Christ. Pray for this mission project and mark under Mission of the Month for November.

Thanksgiving Mission: JOBS FOR LIFE

This is a local program (in existence for 4 ½ years) founded and directed by Rev. Scott Bell and located in the basement of the Tuscarawas County Administration Building.

Quoted from TR article: “We work with those that are coming out of incarceration, homelessness, addiction and just feeling as if they will never get ahead. This population is usually marginalized in towns like Dover/New Philadelphia because we don’t want to admit that we have a marginalized population like that. But I’m here to tell you we do. And so, the mission statement for our organization is this: Meet people where they are.” There are an estimated 175 to 200 people who have graduated from Jobs for Life.

Compass Center accepts no local, state, or federal grant money. They rely totally on donations. Their Faith perspective program is based on the book of Proverbs as they pray with their clients, pray for their clients and hold Sunday morning services dealing one on one with their issues. To date they have seen 7 baptisms and 2 weddings. Praise God!

Pray for this project and use your Thanksgiving envelope or write “Jobs” under other missions on your envelope to give.

Church Conference

Our annual charge conference meeting will be held on Tuesday, November 6th at 6:30pm. Broadway will be hosting this year. Charge Conference is the official, yearly meeting of a local church under the direction of the district superintendent. All our welcome to attend this meeting.



Musical Notes

The Wesleyan Choir is off to a great start this year.

Unfortunately, Marsha and Dave Taylor retired after many years of singing with us, but they are still great supporters of the choir and prayer partners. Thank you, Taylors, for your faithfulness! But we also have welcomed some of our teen girls! Emma Demuth, Addy, and Ally Kendle and Lene, the Kendle's exchange student, sing with us as often as they can given their busy schedules! It's great to have you! And we encourage anyone who likes to sing to join us in the choir!

Christmas Cantata - We have started rehearsals for our annual Christmas Cantata. The Wesleyan Choir will sing "Jesus, No Other Name" on December 16th at the 8:15 service. This is one of our favorite musicals written by Randy Vader and Jay Rouse. Christmas is about Jesus, the One and Only Son of God! We will lift His Name on high when we sing Angels We Have Heard on High, Carol of the Kings, How Great is Our God, What Did You Say was the Baby's Name, No Other Name and many more. If you would like to join us to sing this cantata, please come to rehearsal around 8:00am on Wednesday evenings. We would love to have you sing with us!

Please start inviting friends and family to come on December 16th to hear "Jesus, No Other Name". Invite your unchurched neighbors to this beautiful event! This musical could be a very important part of everyone's Christmas celebration. John 20:31 says, *"But these are written that you may believe that Jesus is the Christ, the Son of God, and that by believing you may have life in His name."*

Broadway Honors Our Veterans

We are so grateful to all of our Veterans for their sacrifice and service to our country, so we want to honor them on Sunday, November 11th at both services! The Wesleyan Choir will sing a 15 minute cantata called "Freedom's Dream" at the 8:15 service. This musical combines patriotic songs like America the Beautiful and Battle Hymn of the Republic with Keep Freedom's Dream Alive and Our Hands Across our Hearts. A Power Point presentation, including pictures of our brave veterans, will accompany our mini cantata. Then Dale Fincher will honor Broadway's Veterans.



If you are new to Broadway or have never had your picture included in our Veterans Day salute, please get a picture of yourself, in uniform, to Kathy Gibson as soon as possible. We want to include all of you! Dale will also honor the Veterans who attend the 10:45 service and Pastor Mick will preach at both services! We want Sunday, November 11th to be a very special day at Broadway!



Don't forget to change your clocks Saturday, November 3rd to one hour back for Daylight Savings Time.

Worship times are
8:15am Traditional
10:45am Contemporary
9:45am Sunday school

Church Council Meeting

Monday, November 12th @ 7pm in Spencer Hall. Everyone is invited to attend! Please note, you must be a member of Church Council to vote. If you would like to bring something to Council, please notify Mike Mossor.

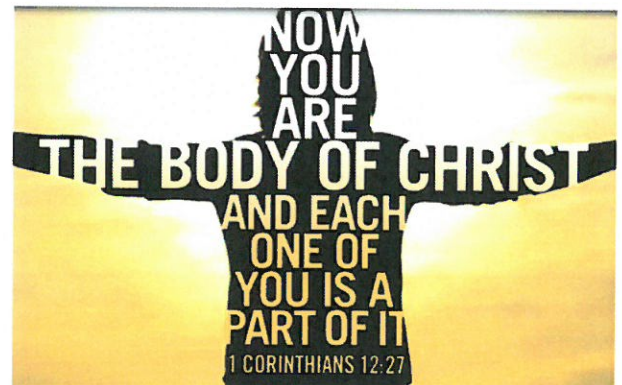

Christmas Eve Candlelight Worship
Sunday, December 24th at 7:00pm
Celebrate the birth of our Savior, Jesus Christ

The shopping is done, presents wrapped and now it's time to stop and focus on the true reason for the season. Jesus Christ, who came to earth as a human child to forgive mankind for its sins, is why we gather on this holiest of nights. This is going to be a special service! We will have our Wesleyan Choir, Praise Team, the Holy Family and more. Invite your friends, neighbors and family. The nursery will be available on Christmas Eve.

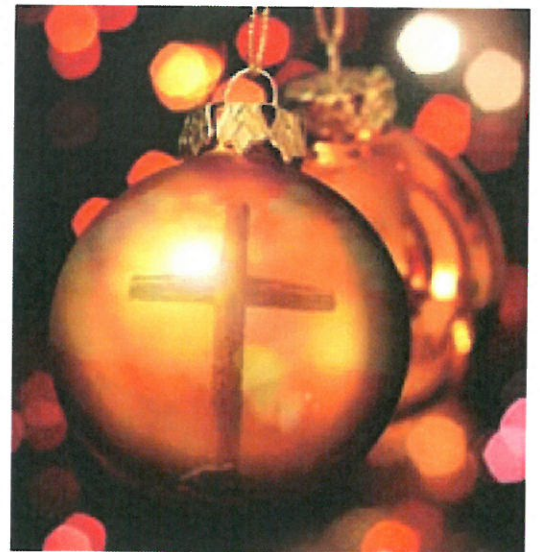

Hanging of the Greens

The Altar Guild would like to invite you to help them with the Hanging of the Greens on **Saturday, December 1st starting at 9:00am**. Won't you please join us to help make our Church beautiful for the coming King?

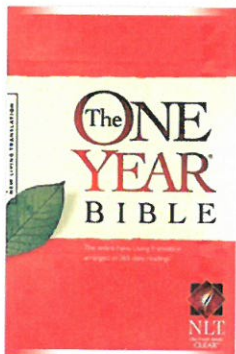

One Year Bibles for Sale

The Bible is the most important and essential book in history, because it is God's Word and His revelation of Himself, His precepts, and His purpose for our lives. As a Christian, you cannot and must not function without it!

The One year Bible daily readings consist of passages from the Old Testament, New Testament, and a Psalms or Proverbs. This arrangement of Scripture brings variety and a fresh approach to each day's reading, while providing a clear understanding of the Bible's larger message.

In the year ahead, ask God each day to speak directly to you from the Scripture portions you read. Be expectant, and let your continual exposure to God's Word reshape your attitudes and behavior as you gain a better understanding of every part of His written testimony to us.

The One Year Bible is a great Christmas gift . Available soon in the Narthex.



December Mission of the Month: **Community Kids**

It is fast approaching the time of year that some of our local school children are needing coats, shoes, hats, gloves, etc for the cold weather. This fund is also used to purchase needed school supplies for students unable to purchase these supplies for themselves as well as cleaning and personal hygiene products.

Prayerfully consider if you want to give to this mission project.

Christmas offering will go to The Salvation Army for their "Red Kettle Ministry".

This campaign is the biggest local fundraiser effort undertaken by The Salvation Army Dover/New Philadelphia, Corps. These funds are used throughout the year to help feed, clothe and house families who have lost their homes in a fire or other disaster and many other projects to help their efforts to assist those most vulnerable in our community.

Please use your Christmas envelope if you wish to give to this project or write "kettle" under other mission on your envelope.



Cards for Heroes will be available for individuals to pick up and sign a personal greeting by the first of November. Instruction and sign-up sheets will be available at the table. These cards must be returned (with a personal message) to the mission committee by November 16th to meet the deadline.

Please note there are two kinds of cards this year. Christmas cards and Thank you/appreciation for your service cards that can be sent anytime of the year.

These cards will go to veterans who are active and inactive.

Christmas Program Sunday December 9th

Heaven and Nature Sing

When Jesus was born, there was joy on earth and in heaven. All of creation join in celebrating this gift from God the father. You are invited to be a part of it of celebrating the Birth of Jesus. This year we are looking for 3 male and 2 female characters:

Harold- an angel who fancies himself a singer

Phaniel- Harold's angel supervisor

Serafina- an angel

Daniel- an angel

Jordon- another angel supervisor

Also looking for speakers and Bible readers. Anyone who would like to participate in any of the parts listed above and sing with us please see Micki Coon.

Singers will be practicing on Sunday's right after church. A light lunch will be provided each Sunday, parents are welcome to join us for lunch. We will eat lunch and then practice from 12:30 pm- 1 pm. Starting Nov. 4th.



Dec. 23 Celebrate Jesus's Birthday during our 10:45 am Worship Service. We will Celebrate by listening to the story of Jesus' birth and thinking about what gifts we can give to Jesus. We will play games and have birthday cake.

Dec. 2 Christmas Caroling: Did you know that Caroling spreads Joy thru Music? Let us spread a little Christmas Joy this year by gathering and visiting our shut-ins that are in the Nursing Homes or at their home by singing Christmas carols. After we are done singing, we will return to the church and have hot chocolate and cookies. If you plan to join us, please sign up in the Narthex by Dec. 1st.



Wednesday Evenings

Kidz Praise Choir and Club meets Wednesday Evenings

6:00 pm – 7:00 pm for ages 3-5th grade. We meet upstairs in the God Squad room.



Come browse our Bake Shoppe...

Broadway Missions Workers are having a Bake Shoppe Sunday, December 16th. All goodies will be available before 8:15am worship and until they are gone in Spencer Hall. The Christmas season is a busy time so plan on swinging by the Bake Shoppe! We will be selling Cookies, Candy and lots of Goodies baked by our ladies. Let those who love to make Christmas goodies take the load off your baking needs.

All funds go toward the Broadway Mission Workers' local missions and nursing home and homebound visitation.

Share-a-Christmas

We are asking for your help of donations of **NEW!** hats, gloves, socks and underwear for low-income families in our county.

Tuscarawas County Job & Family Services has for many years joined forces with T-4-C in an effort to provide food, toys, and clothing to low-income families at Christmastime.

We have placed a large bin in Spencer Hall to place your donations. (NEW! Hats, gloves, underwear and socks. All sizes, from Infants to Small adult).

We will accept donations until **Sunday, December 9th**.

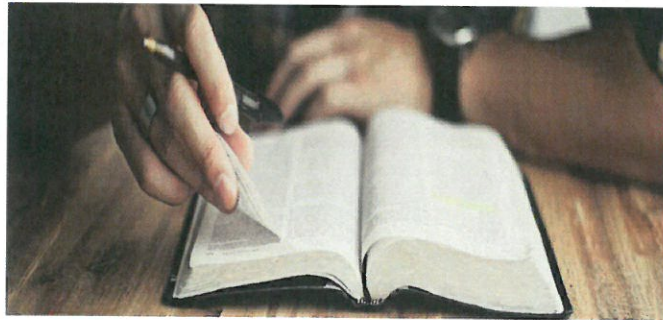
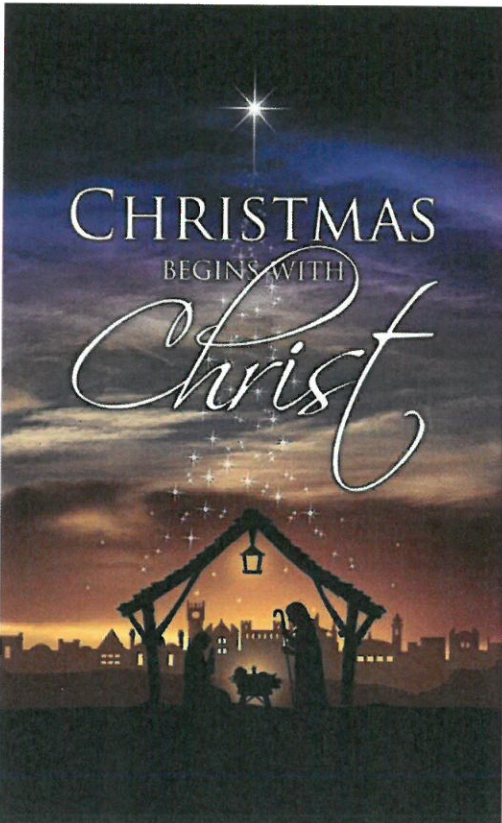

Christmas & New Year Schedule for Bible Studies

The last Bible study of 2018 will be Tuesday, December 18th, @ 9:00am & Wednesday, December 19th @ 6:15pm.

We will then take a break until Wednesday, January 2nd, 2019 at 6:15pm. The Tuesday morning group will start the new year on January 8th at 9:00am.

If we have **bad weather, please listen for the One Call.** Cécily Fincher is in charge of the One Call. Please let her know if you want to be put on a group at the Church.



Broadway's Annual Christmas Dinner will be December 9th. Theme is

"We are Blessed with His Light and His Love."

The Kid's program "Heaven and Nature Sing" in the sanctuary will precede the covered dish dinner in Spencer Hall at 5:30. Sign up sheets for attendance at the dinner and sheets to sign up for the food will be in the Narthex by the second Sunday of November.



Young-at-Heart

The Young-at-Heart luncheon will be Wednesday, November 14th. Lunch will be held at Grinders in Dover

On Wednesday, December 12th, the luncheon will be at Hog Heaven in New Phila. Please call Sheryl Thompson (330) 407-5829 or Carrie Moro (330) 987-6004 for reservations. Lunch is at Noon.



The kids in 10:45am worship gave Pastor Mick a shirt that says, "Best Pastor Ever".

Only God

“Whom have I in heaven, but Thee? And besides Thee, I desire nothing on earth.”

Psalm 73:25



We all have loves in our life. We love our kids. We love our spouse. We love our friends. We love our hobbies. We love our sports. But God calls us to love Him. It seems like a simple command, “Love the Lord your God with all your heart and with all your soul and with all your mind and with all your strength” (Mk. 12:30). But it is a life-long goal that I don’t think we ever achieve here. Stuff gets in the way.

As I think about the people I love and the things I love and the activities I do, I am more apt to cling to them, than to God. But this calling to go to Haiti is something that is beyond this world and these loves of mine. I don’t really understand it. I don’t really know why I need to go. But there is no doubt in my mind that I do need to go and at some point – longer than a week as these last three trips have been.

These trips to Haiti are a taste of the culture and the people and the mission that awaits me. While my heart loves the things and people of my current life, it is hard to think I will be separated from them. Yet, He wants me to believe as Paul did that “whatever things were gain to me, those things I have counted as loss for the sake of Christ” (Phil. 3:7). It is not an easy truth to believe when our heart loves the things of this earth – so much. But it is a truth that we need to believe, I need to believe.

What God offers is more. It is more even if it doesn’t seem like it could possibly be more, because God fulfills in a way we cannot understand. Doing His will fulfills in a way that all the things and persons that we love can never do. With faith, we can believe this truth because “Faith is the assurance of things hoped for, the conviction of things **not seen**” Heb. 11:1. My future is a great unknown, but God is not. He is good and kind and generous and loving. He will not fail when we step out in faith to whatever He calls us to do. Only God is enough.

So I would like to end this with a few questions. What do you love? Are you willing to count them all as loss for the sake of Christ? What is God calling you to?

Lotus McCleery for the team



Broadway
United
Methodist



Youth Ministry

UPCOMING EVENTS

Discipleship Wednesdays
5:30-7:30pm

Fellowship Sundays Noon-2:00pm

SOCIAL MEDIA

www.facebook.com/broadwayumcyouth

@BroadwayUMYouth on Twitter

www.instagram.com/broadwayumcyouth

broadwayumcyouth@hotmail.com

NEWS AND ANNOUNCEMENTS

Summer seems to have left us in a hurry, but we all know we have plenty of good things in store for us this Fall & Winter. We are currently finishing up a series on "Slowing Down". We are learning how the busyness in our lives can take our focus away from our faith. We have so much to do that we become exhausted. Even Jesus got tired, and when he was, he rested. We've discussed how we need to take time to unplug, relax, and most importantly...SLOW DOWN. This will also help us prioritize our lives.

Next up, we are going to be working on a Thanks-Giving series. Yes, it is themed around the holiday, but it has much more than just turkey and stuffing. I'm excited to continue our studies and be a part of our youth's faith journey.

As football season winds down, we will get back to our First Friday events with the Roxford Youth plus much more!

Ryan Best, Youth Director

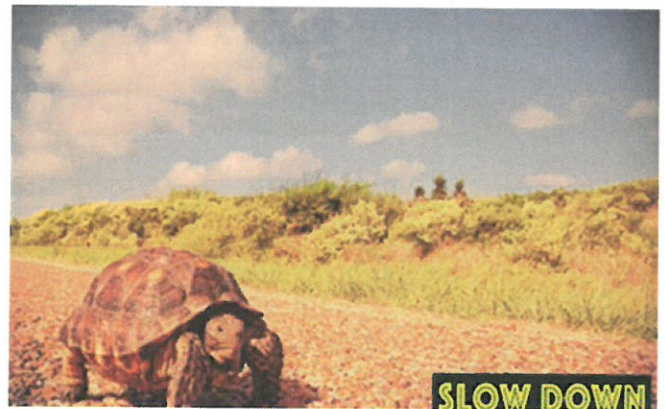

Nursing Home

Country Club Nursing Home

860 East Iron Avenue Ext. Dover 44622
Nancy Leggett -Room 20

New Dawn Health Care & Rehab

865 East Iron Avenue Dover 44622
Bea Taylor (Cindy Akers' mom)- Room 501
Joyce Pipes-Room 507
Judy Miller-Room 509

Northwood Village

5799 North Wooster Ave. Dover 44622
Estelle Myers—Room 320
Dave Myers—Room 502
Harold Swauger—Room 114
Freda Harmon-Room 501

Park Village Southside

1019 Oldtown Valley Rd. SE New Phila. 44663
Norma Laner-Room 21F
Phone: (330) 440-6052
Ida Fox (Charlene Rankin's mom)-Room 20A
Dick Beaber
Dorothy Denning-Room 32H
Lois Jarvis-Apt. 11H

Schoenbrunn Healthcare

2594 East High Avenue New Phila. 44663
Dick Synder (Kathleen Falls' brother)

Hennis Care

1720 North Cross Street Dover 44622
Al Whitmer

Homebound Friends:

Sandy Mast
523 Harger Street Dover 44622

Don & Betty Limbacher
412 Ellen Avenue SW New Phila. 44663



Dear Church Family,
Thank you for your kindness following the passing of Ethel. We are so grateful for everything you did for us. We appreciated the funeral lunch, the many cards, Diane Bell & June Celce for taking care of the church office while I was off, the food brought to the house, Pastor Mick for making mom's service a celebration of life, for those who attended the funeral, but most of all for your prayers and love. We are so thankful for our church family.

God Bless,
Will & Tammy Beavers



November Birthdays

November 4	Jake Miller
November 5	Vic Schrader
November 8	Patsy Shepherd
November 11	Katelyn Ballard Marilyn Stutz
November 12	Cindy McComb
November 14	Mia Akers Pastor Mick Rita Roth Daryl Sowers
November 15	Sondra Demuth Olivia Thomakos
November 18	Katelyn Mamula Mary Sears
November 19	Charles Aubihl Elaine Goddard Tim Larkin
November 21	Bob Hile
November 22	John Das
November 25	Sue Whitmer
November 27	Elizabeth Brantley
November 28	Ruth Burky
November 30	Dorothy Pierson

Happy Anniversary!

November 1	Mike & Cindy McComb
November 10	Tom & Nancy McQueen
November 17	Bob & Judy Thompson
November 19	Bob & Marilyn Stutz
November 20	Kathy & Dennis Whitson

December Birthdays

December 1	David Seabrook
December 4	Maggie Rose
December 5	Mary Tweddle
December 6	Emma Demuth
December 7	Patty Housel
December 8	Carole Finzer
December 9	Kipton Reichman
December 10	Maxine Reichman Lona Roll Mary Kay Laner
December 11	Brian Rose
December 13	Nancy McQueen Emily Mossor
December 14	Lois Jarvis
December 16	Jerry Beaber
December 18	Kathy Whitson
December 19	Joyce Greco Dillon Thomakos
December 22	Marlene Miller Mary Ellen Whipkey
December 25	Dan Mamula Sr.
December 26	Karen Jones Ted Polka
December 27	Helen Ballard
December 28	Norma Laner Bob Mason

Happy Anniversary!

December 11	Chuck & Sondra Demuth
December 13	Rick & Erica Andrews



Membership Classes

If Jesus has called you to grow and serve him alongside believers here at Broadway, you can confirm that all by joining others in the Membership Class led by Pastor Mick. Anyone from age 13 to 103 is invited to come. We will begin January 6th, in the Pastor's study, during Sunday school, looking at basic beliefs for Christians.

2019 Offering Envelopes Coming Soon!

On Sunday, December 23rd, next year's envelopes will be available for you to pick up in the Narthex. Those who give online—an email will be sent to you to find out if you wish to also have regular envelopes in addition to giving online. Please check your emails and let us know.



Broadway Church walked in the Human Trafficking Awareness Walk on October 20th.

Broadway United Methodist Church
120 Church Avenue SE New Phila., Ohio 44663
Office (330) 339-1082
Office Hours: Monday - Thursday 8:00am-4:00pm
E-mail: bumc@broadway-umc.org
Website: broadway-umc.org

Pastor Mick Foster
Worship times: 8:15am Traditional
Nursery care available (birth – 3 years old)
10:45am Contemporary
Nursery & Junior church available
(birth – 12 yrs. old)
9:45am Sunday school
Classes for children, youth and adults

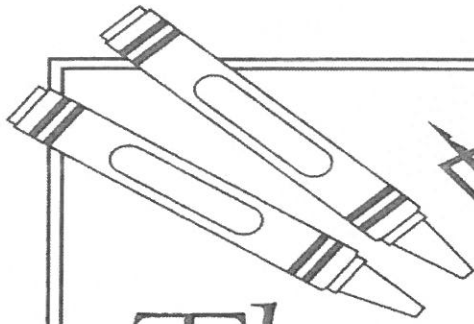

PUZZLE

The angel's message

On the first Christmas Eve, shepherds were watching over their flocks when an angel suddenly appeared.

Use the picture clues below to find out what the angels said to the terrified shepherds.

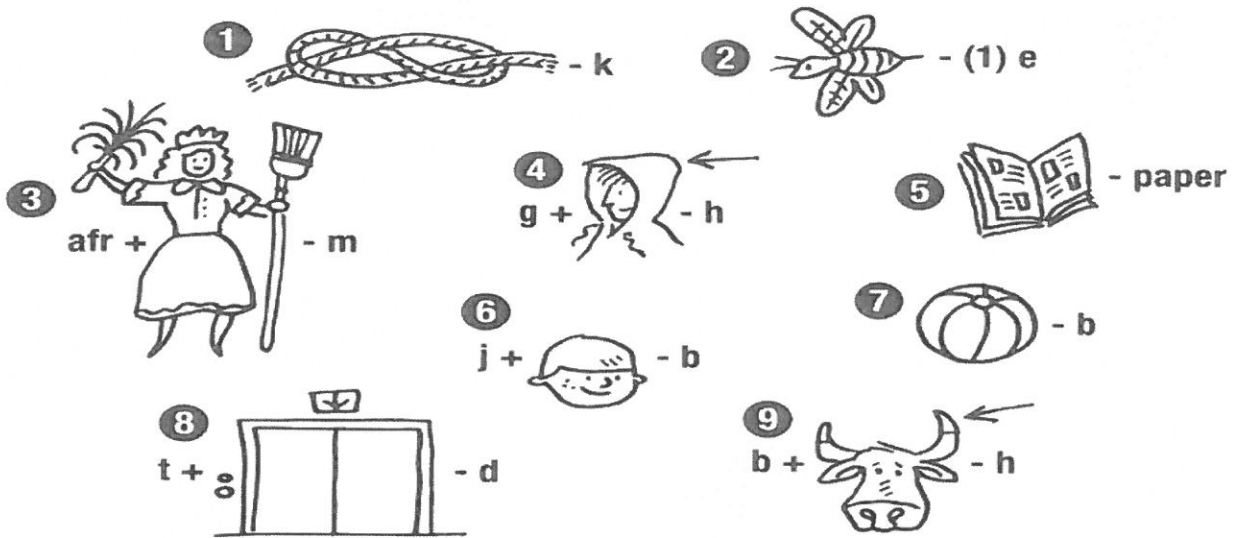

"Do _____ 1 _____ 2 _____ 3. I bring you _____ 4

_____ 5 of great _____ 6 that will be for _____ 7 the people.

Today in the _____ 8 of David a Savior has been _____ 9

to you; **he is Christ the Lord.**" Luke 2:10-11, NIV

"Do not be afraid. I bring you good news of great joy that will be for all the people. Today in the town of David a Savior has been born to you; he is Christ the Lord." Luke 2:10-11, NIV

Answers: 1. knot-k=not; 2. bee-(1)e=be; 3. afr+maid-m=afraid; 4. g+hood-h=good; 5. newspaper-paper=news; 6. j+boy-b=joy; 7. ball-b=all; 8. t+down-d=town; 9. b+horn-h=born

November 2018

Sun	Mon	Tue	Wed	Thu	Fri	Sat
				1 9:30am BTEC 1pm Praise Team 5:30pm Shoebox party 6pm Kara- te	2 3F's= First Friday Fast	3 10am Praise Team 1pm Cindy McComb Spencer Hall
4 All Saint's Sunday Shoeboxes Due Noon Youth	5 6:15pm Cub Scouts 7pm Boy Scouts 7pm Wor- ship Comm.	6 7:30am The Fella's 9am Bible Study 6pm Kara- te 6:30pm Host Church Conference	7 5:30pm Youth 6pm Kids Club 6:15pm Bi- ble study 7:30pm Choir	8 1pm Praise Team 6pm Kara- te	9	10 9am Boy Scouts 9am Pre- pare Salv. Army 10am Praise Team
11 Veteran's Day Noon Youth	12 7pm Church Council 7pm Boy Scouts	13 7:30pm The Fella's 9am Bible Study 6pm Kara- te 6:30pm Cub Scouts	14 9am OS- UEO 5:30pm Youth 6pm Kids Club 6:15pm Bi- ble Study 7:30pm Choir	15 1pm Praise Team 6pm Kara- te 6:30pm Children's ministry mtg.	16	17 10am Praise Team 8am Scrapbook- ing
18 Noon Youth Bible Sun- day	19 7pm Boy Scouts 7pm Trus- tees	20 7:30pm The Fella's 9am Bible Study 6pm Kara- te 6:30pm Cub Scouts	21 5:30pm Youth 6pm Kids Club 6:15pm Bi- ble study 7:30pm Choir	22 Office Closed	23	24 10am Praise Team
25 Noon Youth Christ the King Sun- day	26	27 7:30pm The Fella's 9am Bible Study 6pm Kara- te 6:30pm Cub Scouts	28 5:30pm Youth 6pm Kids Club 6:15pm Bi- ble study 7:30pm Choir	29 1pm Praise Team 6pm Kara- te	30	

December 2018

Sun	Mon	Tue	Wed	Thu	Fri	Sat
						1 9am Pre-prepare Salv. Army 9am Hanging of the Greens
2 Advent starts Noon Youth	3 6:15pm Cub Scouts 7pm Boy Scouts	4 7:30am The Fella's 9am Bible Study 6pm Karate 6:30pm Cub Scouts	5 5:30pm Youth 6pm Kids Club 6:15pm Bible Study 7:30pm Choir	6 9:30am BTEC 1pm Praise Team 6pm Karate	7 3F's First Friday Fast	8 10am Praise Team Prepare Christmas Dinner
9 <i>Family Christmas Dinner</i>	10 7pm Boy Scouts	11 7:30am The Fella's 9am Bible Study 6pm Karate 6:30pm Cub Scouts	12 5:30pm Youth 6pm Kids Club 6:15pm Bible Study 7:30pm Choir	13 1pm Praise Team 6pm Karate	14 Friendship Dinner	15 10am Praise Team
16 8:15am Wesleyan Choir Cantata Noon Youth	17 7pm Trustees	18	19 5:30pm Youth 6pm Kids Club 6:15pm Bible Study 7:30pm Choir	20 1pm Praise Team 6pm Karate	21	22 10am Praise Team
23 Noon Youth	24 7pm Christmas Eve Service	25 Office closed	26 5:30pm Youth 7:30pm Choir	27 1pm Praise Team 6pm Karate	28	29 10am Praise Team
30 Combined Worship	31					