

Broadway GMC News

120 Church Avenue SE
New Philadelphia, Ohio
Pastor Harley Wheeler

We Strive to be Bible Faithful!



Broadway Church & Roxford Church join to present the Living Last Supper

We will observe Maundy Thursday on Thursday, April 6th, with Broadway and Roxford Church joining together to present The Living Last Supper Reenactment.

The Living Last Supper is a moving portrayal of Jesus' last evening with His Disciples. Using the famous painting by Leonardo Da Vinci, we will focus on the moment when the Lord said, "one of you will betray me."

You won't want to miss this event on Thursday, April 6th, @ 7:00 PM.



Easter CELEBRATION

He is not here; He has Risen! (Luke 24:6)

Easter Sunday, April 9

8:30 AM Traditional & 10:45 AM Contemporary Worship

9:45 AM Sunday school

Faith, Hope, Love

***An inspirational concert presented by Malone University Chorale
& Chamber Choir Amplified***

Friday, March 3 at 7:00 PM

St. Joseph Catholic Church 322 3rd Street SE, Massillon

Sunday, March 5 at 7:00 PM

Beech Mennonite Church 10037 Easton Street NE, Louisville

March/April 2023

Gideons is the March Mission of the Month

Broadway purchases Scriptures distributed by The Gideons International locally, and worldwide. Thank you, Broadway!

9 Broadway members currently serve year-round as your local missionaries, along with 265,000 other Gideons and Auxiliary (Gideon wives) worldwide in 199 countries.

The Gideons are a body of believers dedicated to making the Word of God available to everyone and, **together with the local church, reaching souls for Christ.** What began in 1908 as an Association of Christian businessmen placing Bibles in hotel rooms has evolved into an expanding mission to **provide Scriptures to all people in nearly every facet of life.** We exist as **an advocate for the lost,** to bring them the saving knowledge of the Word.



Last week, **shown in the picture,** Ken Harper of the Alliance, Ohio Gideons helped 200 Mexican Gideons distribute 603,4087 Scriptures in Mexico City. Broadway's prayers and funds played a part.

We Gideons also share our personal faith because we realize how often people today need someone to come alongside them in finding their way to true salvation that is available only through the grace of God. As opportunities arise, we take time to share the Gospel message with friends and family, business acquaintances, and other people we meet who are struggling in their daily lives.

Distributing God's Word plants powerful seeds God can use according to His own timing (I Corinthians 3:6), allows many to read the truth for themselves (John 8:32), provides a lasting witness (Hebrews 4:12), and makes it easier for those we reach to boldly spread the Good News (II Timothy 2:2).

As an example Gideon country, the island country of Papua New Guinea in the Pacific is home to nearly 10 million people. 800 of them are Gideons and Auxiliary. The Gideons started in Papua New Guinea in 1980, and have distributed 2 million Scriptures there since then. Again, Broadway's prayers/mission gifts help buy these Scriptures. This picture shows a school distribution.



Please prayerfully consider designating gifts to this mission by using your tithing envelope or writing **Gideons** on your tithing envelope or the memo line on your check.

Tuscarawas County Council for Church and Community
presents:

FREE COMMUNITY LAUNDRY DAYS

TUESDAYS IN MARCH FROM 9AM-12PM

AT PARTICIPATING
FINISH LINE COIN LAUNDRY
DOUER-NEW PHILADELPHIA-DENNISON

4 LOCATIONS:

- 139 FRONT AVE SW NEW PHILADELPHIA, OH 44663
- 130 E. SECOND ST DOUER, OH 44622
- 1125 BOWERS AVE NW NEW PHILADELPHIA, OH 44663
- 1 N. 2ND ST DENNISON, OH 44621

4 LOADS
PER
FAMILY



FEBRUARY 2023

Bright Morning Sunshine

Ephesians 5:14: Therefore it is said, "Awake, sleeper, rise from the dead, and Christ will shine on you."

A warm spring day is like a wake-up call to me. If I am not fully awake and energized on such a day, I feel I ought to be.

The proclamation of the Gospel is, for Paul, the ultimate wake up call, the dawning of a new time, and the bright sunshine poured into the darkest corners of Life.

In Ephesians 5:14, above, he walks us through this gospel-work in our hearts.

First: Awaken! This is a work of God. He sent his Son to us. He suffered on the Cross, He sends the Holy Spirit to prepare us inwardly. The one who wakes up has found that the body is saying that the time for sleep is passed. The awaking heart has completed its waiting and wandering, and is ready for the eyes of the soul to open.

Second: Rise from death! The resurrection is proclaimed. Not only is Jesus alive, but we share in His life. As John 5:25 says, *"The time is coming and is now here, when the dead will hear the voice of the Son of God, and those that hear will live."* We are dead in sins without Christ, but the word of Jesus raises even the dead.

Third: Christ will shine on you! Jesus has a specific will for your life. There are things His light will help you to see, circumstances His light will help you navigate around, and deep places in your soul that will be uncovered by the Light of God for repentance and renewal.

It is a new day in Jesus for you. Let's wake up to that Good news.

Blessings,
Pastor Harley

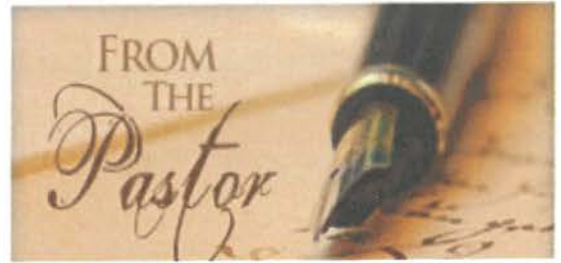

To our old friends and special new friends,

Don and I thank you so much for the wonderful and thoughtful cards. Cards that we've been blessed with all through the year. Each one is special to us and reminds us how blessed we are to be part of Broadway Church. We are blessed! Thank you each and everyone!

Don and Betty Limbacher



The Ken Finzer family wants to thank the Broadway GMC family for all the prayers, cards, and donations in memory of Ken. We are blessed to have Pastor Harley who visited so faithfully at home, Hennis Nursing Home, the hospital and Hospice House. The Memorial Service was certainly a celebration of Ken's life and is available on YouTube thanks to Don Gibson and AV assistants. Thanks to Becky Roth and the bereavement committee for a wonderful meal served after the service.

Carole and Family

An Important Weapon

“And He withdrew from them about a stone’s throw and He knelt down and began to pray, saying, ‘Father, if Thou are willing, remove this cup from Me; yet not My will, but Thine be done.’ ” Luke 22:41,42

In Jesus’ most desperate hour, He knew He needed to pray to His Father. He wanted His disciples “to keep watching and praying” with Him. Jesus asked for their support because He knew great power is unleashed when together we pray. Besides Scripture, “the sword of the Spirit” (Eph. 6:17) being a weapon against the evil one, prayer is also our weapon. Prayer is a weapon against discouragement, against fear, against worry. Prayer is a way to talk to God about what is on our hearts and minds and ask Him for insight, wisdom and comfort. Jesus often went alone to pray (Mark 1:35) even in His most busy times, as an example for us. He wants us to pray, both individually and together. God has provided an opportunity to pray specifically for our church and our new denomination.

We will meet from 9-10 a.m. on the **last Thursday of the month** in the Church library off of Spencer Fellowship Hall to focus prayer on the revitalization of our Church and the Global Methodist Church as a whole. The topics to be covered in this once-a-month, year-long prayer time will be healing, spiritual warfare, revitalization and maintaining vitality. The format includes a short reading, personal reflection, brief discussion and prayer.

Materials have been provided by the Revitalization Task Force of the Wesleyan Covenant Association (WCA). The WCA encourages all Global Methodist churches or those considering joining the new denomination to pray. “If our congregations are to be revitalized...even resurrected in some cases, we have to get to create a space where God’s voice can be heard. We must start with prayer.” (From WCA revitalization materials)

We will also continue to meet at 9:00-10:00 AM Thursday in the library for regular prayer meetings. These are more informal times of praise, sharing, and praying for personal and church needs. We have sensed God’s Holy Spirit present and it is a great time of encouragement! All are welcome, whether comfortable praying out loud or in silence. Whether you come to the revitalization prayer meeting once a month or our regular prayer meeting, you will be warmly received. Feel free to call Lotus McCleery at 330-308-5465 with any questions.

Operation Christmas Child NEWS

Worth repeating:

I love O.C.C./Samaritans' Purse, so I would like to give you some food for thought. How many mistakes does it take to get a shoebox right? Sharing with you a few stories I've heard from the children. A 14-year-old boy receives a tiny frilly pink dress. Someone must surely have made a colossal mistake. But wait, he gets all excited because God really does answer prayers. You see, he had prayed for a dress for his little sister!

Another box was specifically packed for a teenage girl, complete with a sewing kit and scissors, but the box was put into the hands of a boy instead. Mistake again, or is it? His Mother sewed for a living and needed scissors. A young girl had been praying for snow. She received a snow globe, oops, that's liquid and glass, which aren't supposed to be in shoe boxes. But she knew God answered prayers!!

Yet another boy opened a box to find nothing but socks. Not a very desirable gift, but WHAT! He says that is all he was praying for. He had severely burned legs from a fire and never had socks.

The list goes on. I pray we don't get so hung up on packing the perfect gifts that we miss the miracle. I know there are many cultural and social barriers to cross, but God has all the addresses and loves answering the children's prayers. Have fun packing, and be Blessed! Posted on Facebook by Liz Yoder (Liz is our O.C.C. Mission trip coordinator)

These are just a few of the many shoebox miracles we hear about at the processing center in Charlotte, NC.

Thank you for your continued support of Operation Christmas Child. Without your help, it would be impossible to bless the children with the gift of a shoe box and the Gospel Opportunity of knowing Jesus Christ.

Mission Trip to Operation Christmas Child Processing Center

If you are interested in going on this mission trip for O.C.C. to Charlotte, NC, contact Becky Roth. Registration and downpayment are due June 1, 2023 (to reserve your bus seat and room)—trip dates are November 26th -29th, 2023.

For ***March and April, we will collect huggables*** (beanie babies, stuffed animals, baby dolls, etc.) **or any toys** (cars, trucks, balls, yo-yo's, jacks, marbles, jump ropes, etc.)

“Let the little children come to Me, and do not forbid them; for of such is the kingdom of God”—Mark 10:14



Your Witness—Way to Go, Asbury! You're A Witness - by Don Gibson

Now this is news, I say! **Good News**. Sure beats the typical stuff in the paper, on radio and TV. That February 8th **Asbury University chapel service** is still going strong 12 days later, at least on this newsletter's publication date. You know what? Twelve-day worship services are not the norm. Notice it's not the pastor pushing the limits—it's the worshipers.

Wait! Is there a limit? Where does it say worship has to end in an hour or two. Broadly speaking, maybe our whole lives should be worship. Kinda goes with **1 Thesalonians 5:17** "Pray without ceasing."

Don't you love this? I do! After the February 8th chapel service, a number of students just felt like sticking around afterwards. They worshipped. More returned. And more. Then it went viral. Then Christians came from, says Breitbart News, the University of Kentucky, the University of the Cumberlands, Purdue University, Indiana Wesleyan University, Ohio Christian University, Transylvania University, Midway University, Lee University, Georgetown College, Mt. Vernon Nazarene University, and others. They filled Hughes Auditorium, and their spilling over into additional facilities with simulcasts.

Of course you can see it on Asbury's website. Last report I recall is 3,000 believers came from Kentucky and beyond to worship the Lord God Almighty. It's so big in drawing people to multiple buildings that its shifting off-campus with a schedule instead of being ongoing around the clock.

Explanations and plan details are posted on Asbury University's website <https://www.asbury.edu/outpouring>.

Here's my point. This is a witness in my book. That's what I like about it. The U.S.A., and even the world are **witnessing** Christ-followers doing round-the-clock worship: singing, praying, Scripture and testimonies—honoring Jesus. **It's real!** No show. No performance. No glitz. I saw a bit of it on TV news. And more on the website. Breitbart News says millions are watching. It seems these worshipers are seeking Christ. They're not there because of duty. They just want to worship. They didn't design and plan it. They didn't line up the media coverage. They're there to worship, as the Spirit leads. It's a witness.

I hope it turns into Psalm 22:27 "*All the ends of the world shall remember and turn unto the LORD: and all the kindreds of the nations shall worship before thee.*"

This column repeats monthly. Got a witnessing question or testimony to share? Call me at 330-260-7837 or email dgibson@linkpointplanning.com, or contact Tammy in the office. Thank you! – Don



Broadway Church Family Dinner & Talent Show

Mark your calendar for May 7th for food, fun, fellowship, and entertainment. We will have a family dinner on May 7th, and you and your families can be a part of the entertainment. The talent could be a skit, playing an instrument, singing, a special reading, juggling, gymnastics, or surprising us all!

Watch for a sign-up sheet in the Narthex for dinner reservations.

We will also ask you to register your talent for the talent show. Slips will be available to fill out your name and talent. Let's share our talents with our Church family at our Church family dinner.

CHURCH-WIDE RUMMAGE SALE

"One man's junk is another man's treasure," as the saying goes:

It's time to declutter your junk for someone to find their treasure at our rummage sale on August 25th. That's right, another way for you to support OPERATION CHRISTMAS CHILD. All sales proceeds will go for supplies and shipping of shoe boxes. So save your treasures and bring them to the Church the week of August 20th, 2023.



Operation Christmas Child

Because of your generosity throughout 2022, we have sent over 1100 shoe box Gospel Opportunities to children worldwide through Samaritan's Purse. In November, we had eight from Broadway and eight of their friends representing us at the Charlotte, NC, Processing Center. Our boxes this year have been processed and are waiting for shipping, and the countries are to be determined. Our mission of packing shoe boxes is an ongoing mission throughout the year. We begin right after our packing party; we start purchasing and processing items for our next party. Thank you again for your generosity and love for Operation Christmas Child. We will collect soap and washcloths for January and February if you want to purchase items.

"Let the little children come to Me, and do not forbid them; for of such is the kingdom of God"—Mark 10:14

Nursing Home

Northwood Village

5799 North Wooster Ave. Dover 44622

Nancy Berry (Denise Graham's mother)-204

Sheryl Thompson- 510

Park Village Southside

1019 Oldtown Valley Rd. SE New Phila. 44663

Dick Beaber—14C

Chuck Aubihl—25F

Lois Jarvis—1H

Nancy Ebersbach—24C

Park Village

1525 North Crater Ave. Dover 44622

Don Storad (Sally Storad's father-in-law)

Suzanne Ballard—412

Hennis Care Center

300 Yant Street, Bolivar 44612

Tom Korns—312

Bolivar Horizons

10071 State Rt. 212, Bolivar 44612

Jennifer George

Schoenbrunn Healthcare

2594 East High Ave. New Phila. 44663

Elly Ash Missionary for Kenya Kids



Homebound Friends:

Don & Betty Limbacher

412 Ellen Avenue SW New Phila. 44663

Dick Housel

1729 Oldtown Va. Rd, SE New Phila.

Don & Hazel Graff

815 Third Street, SW New Phila.

Clifford Shepherd

719 Third Street, SE New Phila.

Phil Neiger

3739 Kneuss Road, NW New Phila.

Sue Whitmer

2309 Tabor Rd. NE New Phila.

Maxine Reichman

216 Creekside SE New Phila.

Joyce Greco

1291 Hilltop Road, NW New Phila.

Donna Deedrich

144 North Avenue, NW New Phila.

Kris Bragg

2189 Possum Hollow Rd. SE New Phila.

Ginger Whitmore

3301 Cobble Stone Drive
Washington, PA 15301

Spring

To what purpose, April, do you return
again?

Beauty is not enough.

You can no longer quiet me with the
redness

Of little leaves opening stickily.

I know what I know.

The sun is hot on my neck as I observe

The spikes of the crocus.

The smell of the earth is good.

March Birthdays



March 1	Todd Kendle
March 2	Tim Holman
March 5	Ally Kendle Preston Weaver
March 16	Tristan Laughlin
March 20	Nelda Sedares
March 21	Frankie Robinbson
March 22	Mike McComb
March 27	Dave Taylor

Happy Anniversary!

March 20	Tim & Michelle Stillion
March 21	Steve & Elizabeth Thomakos

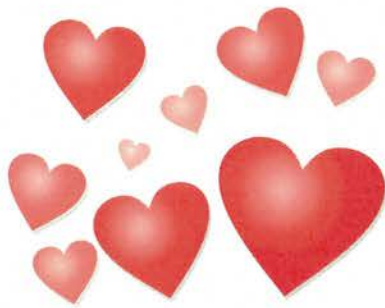

I am what I am

I am not what I ought to be. I am not what I want to be. I am not what I hope to be. But still, I am not what I used to be. And by the grace of Gd, I am what I am. —John Newton

Happy Birthday

April Birthdays

April 1	Diane Bell
April 2	Christa Demuth Kayleigh Rowland
April 5	Steve Gibson
April 8	Shelly Hawthorne
April 13	Sue Neiger
April 14	Donna Deedrick
April 16	Pam Hykes
April 17	Nancy West
April 20	Don Gibson
April 22	Ryan Best
April 23	Joan Schroeder
April 25	Chris Demuth Ed West
April 30	Pat Proctor Ginger Whitmore—90 years old



April 3	Tim & Denise Larkin
April 16	Dave & Lona Roll
April 22	Will & Tammy Beavers

Impact Youth Schedule for March/April 2023

March 1st- Discipleship at Broadway from 6:30-7:30 pm

March 4th- First Saturday Fusion at the Roxford FLC 7:00-9:30 pm
Broadway p/u at 6:30 and drop off at 10:00.

March 8th- Discipleship at Broadway from 6:30-7:30 pm

March 12th- Bowling with the Pastors! 4pm at Boulevard Lanes.

March 15th- Discipleship at Broadway from 6:30-7:30 pm

March 19th- Youth at Roxford 6:00-7:30 pm. (Broadway p/u at 5:30. Drop off at 8)

March 22nd- Discipleship at Broadway from 6:30-7:30 pm.

March 26th- Youth at Broadway from 6:00-7:30 pm.

March 29th- Discipleship at Broadway from 6:30-7:30

April 1st- First Saturday Fusion: Jerusalem Walk Roxford p/u at 5:30 and drop off at 9:00 pm. Broadway p/u at 6:00 and drop off at 8:30 pm.

April 5th- Discipleship at Broadway from 6:30-7:30 pm.

April 9th- Happy Easter! No youth this evening.

April 12th- Discipleship at Broadway from 6:30-7:30 pm.

April 16th- Youth at Roxford 6:00-7:30 pm. (Broadway p/u at 5:30. Drop off at 8)

April 19th- Discipleship at Broadway from 6:30-7:30 pm.

April 23rd- Youth at Broadway from 6:00-7:30 pm.

April 26th- Discipleship at Broadway from 6:30-7:30 pm.

April 30th- Youth at Roxford 6:00-7:30 pm. (Broadway p/u at 5:30. Drop off at 8)

Spring forward into fun and faith this season! We have so much growing to do!

Youth Ministry Director

Shelly Hawthorne 330-432-7520



April Mission of the Month-Pastor Elbarre in Haiti

In the summers of 2016-2018, Broadway sent a team of persons to do ministry through Praying Pelican Missions (PPM) at Manze Marie Church located in the mountains of southern Haiti. Pastor Elbarre Saint Juste was the local pastor who identified the needs in the community where we could help. We visited community members, helped build a new school building, repaired homes and provided Vacation Bible School for the children. When we decided not to go back in 2019 due to the dangerous conditions in Haiti, specifically the Port Au Prince area, we sent the funds raised to build a well, conduct medical clinics, provide COVID information and masks and provide fencing for animals they could raise to support the school.

Praying Pelican Missions has begun a new program to provide support to the local pastors they work with since the conditions are still unsafe to send teams to Haiti. The new program is called PPM365 which provides for a local pastor's medical needs, training, and relational support with other Haitian pastors as well as the means for each pastor to do mission within their community.

When I reached out to Anna Morgan, the PPM365 leader, I asked if Pastor Elbarre was part of the program. She said, "Oh yes. We know Pastor Elbarre very well. In fact, he led 70 persons to minister to neighboring towns." She also provided the following information from his profile.

"Pastor Elbarre grew up in a Christian home where his family always taught him to walk in faith. But he never expected God would eventually call him into full-time ministry! When he started, things were not easy, but God taught him patience and entrusted him with more and more as he matured. He has been in full-time ministry since 1988 (35 years), pastoring at Manze Marie since 2008. He and his wife have been married since 2001 and have one child together."

"The church desires to spread the Gospel to their community and be a place for children and families to go for activities and support. They want to continue spreading the love of Jesus with their neighbors and bring up disciples in the church."

Our team members can attest to the fact this church was a hub for the community and they love and respect Pastor Elbarre very much. He has a joyful spirit and we could sense his love for his people.

The Missions Committee has designated Pastor Elbarre to be the **Mission of the Month for April**. Any funds donated over the \$2400 considered full support of the pastor will be used for projects to help the church in their mission to their community. Another local Haitian pastor who is on staff with PPM will work with Pastor Elbarre to identify the projects and dispense the funds as needed. Any disbursement of funds require receipts be sent to PPM which is located in Minneapolis, MN. I hope you will prayerfully consider supporting Pastor Elbarre in April as Mission of the Month.

Lotus McCleery, past Haiti team leader

APRIL MISSION OF THE MONTH-Pastor Elbarre in Haiti.

Support for Pastor Elbarre will be used to build up, encourage and assist him in his ministry at Manze Marie Church in southern Haiti. Funds will provide for his emergency and medical needs, relational network and training and empowerment to go on mission with church members. Pastor Elbarre is the pastor Broadway team members worked with in the summers of 2016-2018 when we did visitation, conducted VBS, repaired homes and built a new school there. Any funds donated over the \$2400 considered full support of the pastor will be used for projects to help the church in their mission to their community. Another local Haitian pastor who is on staff with Praying Pelican Missions will work with Pastor Elbarre to identify the projects and dispense the funds as needed. Any disbursement of funds require receipts be sent to PPM which is located in Minneapolis, MN. I hope you will prayerfully consider supporting Pastor Elbarre and his church. Lotus McCleery, past Haiti team leader.

Please prayerfully consider designating gifts to this mission by giving to the monthly mission line on your tithing envelope or write **Haiti** on the memo line on your check.

Easter Mission: Tuscarawas County Blessings in a Backpack



Blessings in a Backpack mobilizes communities, individuals, and resources to provide weekend food for New Philadelphia school-aged children who might otherwise go hungry.

Three out of five teachers say they have children in their classrooms who regularly come to school hungry. More than half of teachers (53%) say they purchase food for hungry kids in their classrooms.

On average, \$150 will feed one child on the weekends for one 38-week school year through the Blessings in a Backpack program—the results: nourished kids ready to learn. Food is an essential building block; in this case, it is truly a blessing, especially to a hungry child!

A "hunger cliff" is looming for millions of Americans, with 32 states set to slash food-stamp benefits beginning in March. According to data from the U.S. Department of Agriculture, the cuts will impact more than 30 million people enrolled in the Supplemental Nutrition Assistance Program. The children in our community will need programs like Blessings in a Backpack even more.

Please prayerfully consider designating gifts to this mission by using your Easter tithing envelope or writing **Backpack** on your tithing envelope or the memo line on your check.

FRIENDS OF ISRAEL

2023 PROPHECY UP CLOSE · ONE-DAY CONFERENCE



THE TEMPLE

**GOD'S HOME ON EARTH REVEALED
IN PROPHECY AND PRACTICE**

WITH SPEAKERS



**MIKE
STALLARD**

AND



**CHRIS
KATULKA**

**APRIL 15, 2023 | 9 AM-3 PM
MARANATHA BIBLE CHURCH
1424 KILLIAN ROAD
AKRON, OHIO 44312**

REGISTER AT [FOI.ORG/PROPHECY](https://foi.org/prophecy)

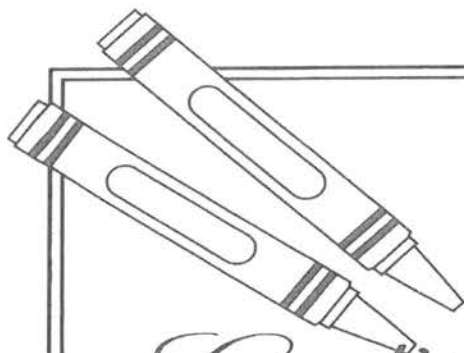

Just for

KIDS

God's teaching is like....

In Deuteronomy, Moses' words to the children of Israel remind us of spring, which brings growth and new life.

Use the flower code below to fill in the blanks, revealing Deuteronomy 32:2, NIV.



“Let my teaching fall like

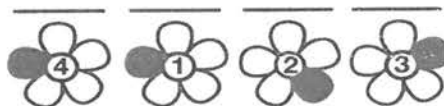

and my words descend like



like



like abundant

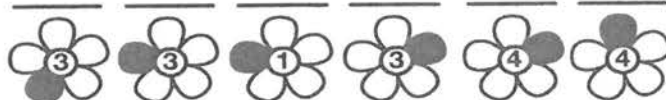
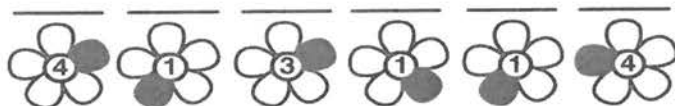

Answers: rain, dew, showers on new grass, rain on tender plants

Pastor Kory's YouTube Bible Study

Pastor Kory Rowland has begun a new YouTube Bible Study! You can join on **Youtube A Voice Crying Out in the Wilderness**. Just click the Live tab to see passed Bible studies or join the newest one.

Bible study is held Thursdays at 6:30 PM. You can type questions in the comment box, and Pastor Kory will include those in the Bible study.



Roxford Church Monthly Breakfast

Come have breakfast with the "Big Guy" Brother Jim Manbeck
Saturday, March 4th, from 8:00-10:00 AM

Roxford Family Life Center
661 Roxford Church Rd SE, Dennison, OH 44621

Come for fellowship and eggs, bacon, sausage gravy & biscuits, mush and more.

Freewill offering, sponsored by Roxford Safety Team, Everyone welcome!

Without Jesus...

Without the risen Savior in our hearts, life is like:

- A chocolate Easter Bunny—empty on the inside
 - An Easter bonnet —easily blown off kilter
 - Last year's Easter outfit —it doesn't quite fit right
 - An Easter lily —it soon withers and dries up
 - A bag of jellybeans —sugary and sweet but lacking substance
 - An unfound Easter basket —full of gifts that spoil and go to waste
 - A colored Easter egg —looks great but cracks under pressure
 - The Easter bunny —always hopping here and there
 - Marshmallow Peeps —becomes hard when opened up
 - Easter parade —a long journey with no destination
 - An unopened Easter card —a message of love unclaimed.
-

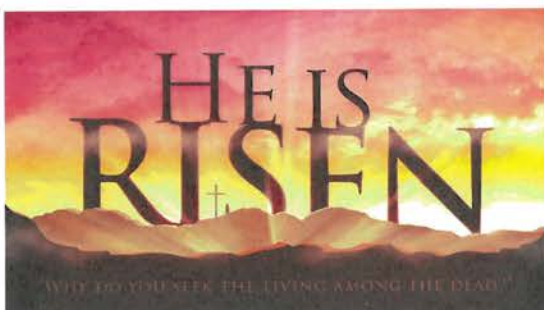

"The resurrection gives my life meaning and direction and the opportunity to start over no matter what my circumstances."
—Robert Flatt

Moses is at Sight and Sound

Join Kathy and Don Gibson as they visit "**Moses**" at the Sight and Sound Theater in Lancaster, PA, on May 3rd and 4th, 2023. Perhaps some of you saw Moses at Sight and Sound many years ago; however, with the new technologies that only Sight and Sound uses, it will be a brand-new experience for you! We'll follow Moses through his childhood to being called by God at the burning bush and leading the Israelites out of Egypt. We'll see Moses receiving the 10 Commandments, and I can only imagine how they will show the parting of the Red Sea! Join us and see for yourself! The theater's acting, music, and live animals keep everything very exciting. Moses will only be at Sight and Sound for one season, so you want to take advantage of it. The trip also includes:

- Experiencing Kitchen Kettle Village.
- The Railroad Museum of Pennsylvania.
- We'll eat at Miller Smorgasbord and stay at the beautiful Fulton Steamboat Inn.

The trip costs \$469 per person, with two people in a room. That includes the hotel, motor coach, admission to "Moses," breakfast at the hotel, and lunch at Millers. The deadline for signing up for the trip is April 1, so make your reservations quickly! Flyers are available from Kathy or in the airlock between the entry doors. For reservations, call Warther Tours at 330-556-4535.

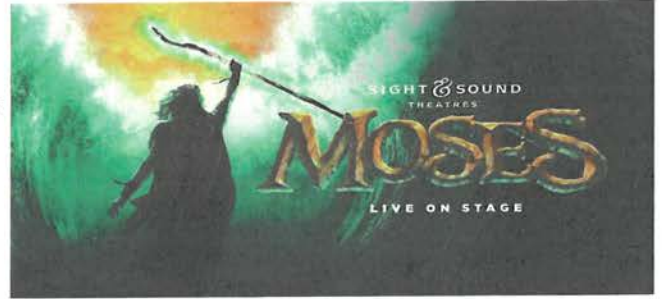

New Experiences at the Creation Museum and the Ark Encounter

Kathy and Don are returning to the Creation Museum & the Ark Encounter. Many of you have been to these two amazing attractions, but there are new exhibits to see and experience that make a return trip very worthwhile! The dates are August 24th and 25th. The Creation Museum includes new displays, including Borderland: Israel at the Time of Jesus. It takes you back to when Jesus walked the streets of Jerusalem. There is also a new exhibit called "Fearfully and Wonderfully Made," which is a testimony to the wonder and sanctity of human life.

40 Days and 40 Nights of Gospel Music returns to the Ark Encounter!

It was a tremendous experience last year that we look forward to on Friday! In addition to experiencing the amazing life-sized Ark, we will see and hear the music of Ernie Hasse and Signature Sound and the Guardians, and Ken Ham, creator of Answers in Genesis, is scheduled to speak! Even if you've seen the Ark many times, special speakers and gospel music events are going on all day at the Answers Center, within walking distance of the Ark. There is also a new virtual theater experience where you can watch Noah as he builds the Ark, loads the animals and watches the flood waters rise.

The trip also includes a relaxing riverboat ride on the Ohio River with more gospel music and delicious food. This trip costs \$469 per person with two people in a room. The deadline for signing up for this trip is July 20th. Again, flyers are available from Kathy or in the airlock between the entry doors. Call Warthers Tours (330) 556-4535 to book your reservation.



Scan to link to Broadway's website:
thebroadwaychurch.org

March 5	"Rising From the Cornerstone"	Ephesians 2:20-22
March 12	"The UN-Qualified"	Ephesians 3:4-6
March 19	"Given as a Sermon"	Ephesians 3:7-9
March 26	"Loving Those Who Hate You"	2 Samuel 19:1-8
April 2	<i>Palm Sunday/Communion</i>	
	"High Espionage"	Luke 19:28-40 April 6
April 6	<i>Maundy Thursday</i> "The Living Last Supper"	
April 9	<i>Easter Sunday</i> "Death Shall Die"	Mark 15:42-16:7
April 16	"Promise of Eternal Life"	1 John 2:24-25
April 23	"The Important Question"	Matthew 16:26
April 30	"Restart, Renew, Revive"	2 Samuel 19: 9-15



Jelly Bean Prayer

Red is for the blood He gave.
 Green is for the grass He made.
 Yellow is for the sun so bright.
 Orange is for edge of night.
 Black is for the sins we made.
 White is for the grace He gave.
 Purple is for His hours of sorrow.
 Pink is for our new tomorrow.
 A bag full of jelly beans.
 So colorful so bright.



Is a prayer, is a promise, to a child of God a treat.

Broadway Global Methodist Church
We strive to be Bible faithful!
 120 Church Avenue SE New Phila. Ohio 44663
 Office Phone: (330) 339-1082
 Office Hours: Monday - Thursday 8:00am-4:00pm
 E-mail: tammy@thebroadwaychurch.org

Pastor Harley Wheeler
Worship times:
 8:30am Traditional
 10:45am Contemporary
 9:45am Sunday school
 Website: thebroadwaychurch.org